

P/T Plug General Specification

Body: Brass
 Core: Nordel
 Design: Dual Core
 Max Press: 1000psi
 Max Temp: 350°F

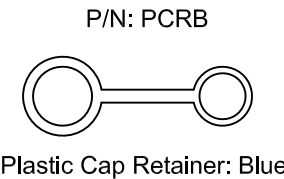
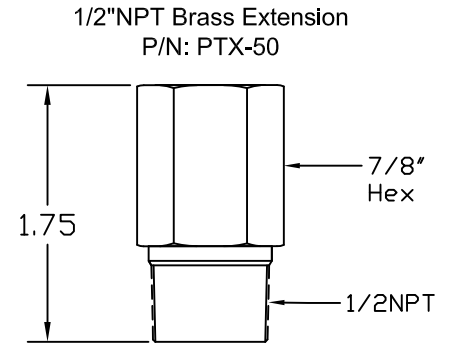
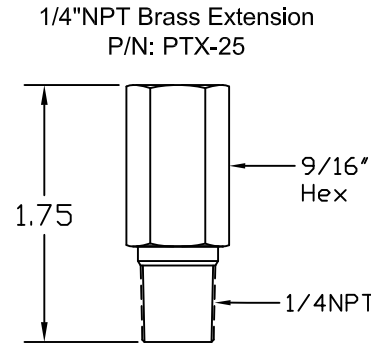
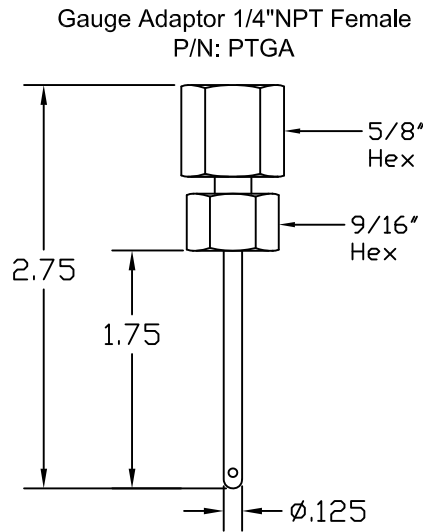
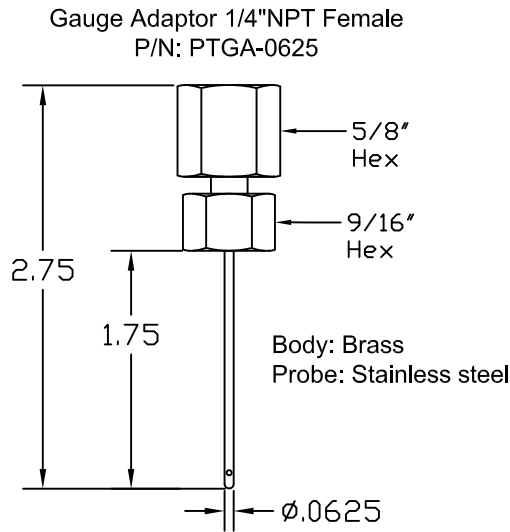
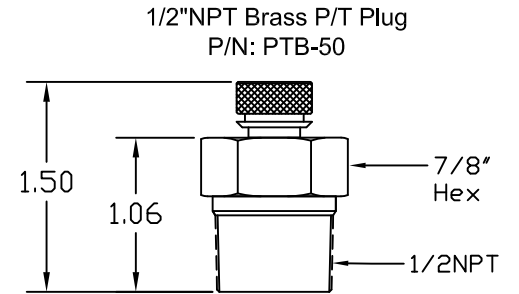
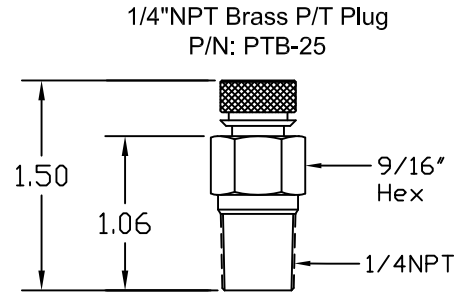
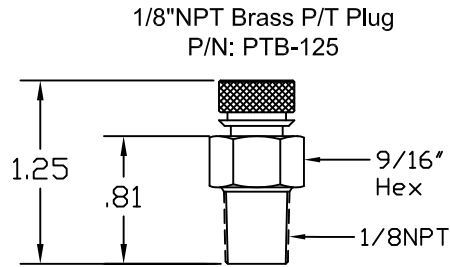

Customer: _____
 Project: _____
 Engineer: _____
 Pro or PO#: _____

MILJOCO

CORPORATION 200 Elizabeth Street, Mt. Clemens, Michigan 48043 USA

SCALE: None	APPROVED BY:	DRAWN BY: HMT
DATE: 3/14/17		REVISED:

Pressure/Temperature Plugs & Accessories

PART NUMBER:	DRAWING NUMBER: 127-134
DIMENSIONS: Inches [Metric] Inches: .xx ± .010 .xxx ± .005 [Metric]: .xx ± .25 .xxx ± .13	